

Zestaw 10 końcówek wkrętakowych + uchwyt magnetyczny, w etui z tworzywa sztucznego

1/4

- 860LP 0,5x3 - 1,0x5,5 - 1,2x6,5 mm
- 860PH PH1 - PH2 (x2) - PH3
- 860PZ PZ1 - PZ2 - PZ3
- 882M1 ○ 1/4" - ● 1/4"



860MIX/A10 008600900



Zestaw 10 końcówek wkrętakowych profil Torx® + uchwyt magnetyczny, w etui z tworzywa sztucznego

1/4

- 860TX T7-T8-T9-T10-T15
T20-T25-T27-T30-T40
- 882M1 ○ 1/4" - ● 1/4"



860TX/A10 008600970

NOWOŚĆ

1/4

Zestaw pokrętła z dwukierunkowym mechanizmem zapadkowym, z uchwytem przejściowym do nasadek i z przedłużaczem 80 mm

860/55

Kąt powrotu 5°

892/0

882P/80

860/S3 008600875



Zestaw pokręteł

- Odpowiedni do prac w miejscach o ograniczonym dostępie
- Radełkowana tarcza ułatwia szybkie dokręcanie

3/8"

1/4"

925/S2 009250755

Zestaw 25 końcówek wkrętakowych, 1 łącznika przejściowego i 1 pokrętła z dwukierunkowym mechanizmem zapadkowym

1/4

- 860LP 0,5x3-1,0x5,5-1,2x6,5 mm
- 860PE 2-2,5-3-4-5-6-mm
- 860PH PH1-PH2(x2)-PH3
- 860TX T6-T8-T10-T15-T20-T25-T30-T40
- 860PZ PZ1 - PZ2(2x) - PZ3

- 860/55
- 892/0

860/C27 008600880



Komplet 7 końcówek wkrętakowych z nasadkami sześciokątnymi, magnetycznych

1/4

- 862F 5,5-6-7-8-10-12-13 mm

862F/A7 008620950



Komplet 15 kluczy płasko-oczkowych ze stojakiem

6-7-8-9-10-11-12-13-14-15
16-17-19-22-24 mm



42/SP15 000420078

Komplet 9 kluczy płasko-oczkowych, w etui

8-10-11-12-13-14-15-17-19 mm



42/SC9I 000420087

Komplet 9 kluczy płasko-oczkowych z dwukierunkowym mechanizmem zapadkowym, w etui

8-10-11-12-13-14-15-17-19 mm



142/SC9I 001420087

Komplet 5 kluczy oczkowych dwustronnych, odgiętych o 15°, z dwukierunkowym mechanizmem zapadkowym, w pokrowcu

8x10-12x13-14x15-16x18-17x19 mm



195P/B5 001950266

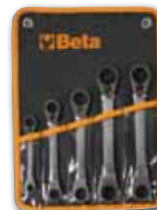

Zestaw 4 uchwytów przejściowych do zastosowania z kluczami oczkowymi:

1 uchwyt przejściowy do końcówek wkrętakowych
3 uchwyty przejściowe z blokadą nasadek



123/K4 001230504

Komplet 12 kluczy płasko-oczkowych prostych, krótkich, z mechanizmem zapadkowym, w etui

8-9-10-11-12-13-14-15
16-17-18-19 mm



142C/A12 001420175

Komplet 2 kluczy oczkowych z dwukierunkowym mechanizmem zapadkowym, dwunastokątnych



KĄT POWROTU 5°

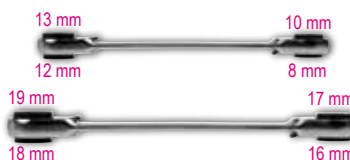

192/S2 001920070

Komplet 7 kluczy płaskich dwustronnych ze stojakiem

☞ 6x7-8x9-10x11-12x13-14x15-16x17-18x19 mm



55/SP7 📄 000550167



Komplet 7 kluczy oczkowych odsadzonych dwustronnych

☞ 6x7-8x9-10x11-12x13-14x15-16x17-18x19 mm



90/S7 📄 000900163



NOWOŚĆ

Skala w mm/calach

Klucze płaskie nastawne ze skalą chromowaną, rękojeści z kompozytu dwumateriałowego

- Śruba regulacyjna prawoskrętna
- Skala w mm i w calach
- Ergonomiczna rękojeść



Ergonomiczna rękojeść

L 200 mm A max 28 mm
111G/200 📄 001110620

L 250 mm A max 32 mm
111G/250 📄 001110625

L 300 mm A max 36 mm
111G/300 📄 001110630

Komplet 6 kluczy nasadowych długich, z rękojeścią kompozytową

☉ 5-6-7-8-10-13 mm

Betamax
MAXIMUM PERFORMANCE

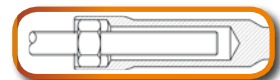

944BX/D6 📄 009440056



Zestaw 11 nasadek sześciokątnych,
21 końcówek wkrętownych
z akcesoriami

1/4" 14

Beta
Mini

	861LP	●	0,6x4,5-1,2x6,5-1,2x8 mm
	861PE	●	2,5-3-4-5-6 mm
	861PH	⊕	1-2-3
	861PZ	⊕	1-2-3
	861RTX	⊗	10-15-20-25-27-30-40 mm
	892/0		
	895/1		
	900	○	5-5,5-6-7-8-9-10-11-12-13-14 mm
	900/20		50 mm
	900/2L		100 mm
	900/25		
	900BG/30C		
	900/55	⊗	



Innowacyjny system
otwierania pudełka



900/C39

009000937

150x95x50 mm

Zestaw 11 nasadek sześciokątnych,
20 końcówek wkrętownych
z akcesoriami,
w pudełku metalowym

1/4" 14

	861LP	●	0,5x3-0,8x5,5-1x5,5-1,2x6,5 mm
	861PE	●	3-4-5-6-8 mm
	861PH	⊕	0-1-2-3
	861TX	⊗	T8-T10-T15-T20-T25-T30-T40
	895/1		
	900	○	5-5,5-6-7-8-9-10-11-12-13-14 mm
	900/16	□ 1/4 - ■ 3/8	
	900/20		50 mm
	900/21		150 mm
	900/25		
	900BG/30		
	900/55	⊗	
	900/55		



270x120x45 mm

900/C11

009000971

Zestaw 16 nasadek z akcesoriami,
w pudełku metalowym

3/8"

	910A	○	6-7-8-9-10-11-12-13-14 15-16-17-18-19-21-22 mm
	910/21		125 mm
	910/22		250 mm
	910/25		
	910/42		
	910/55	⊗	







910A/C16

009100936

335x145x60 mm



Zestaw 12 nasadek z 5 akcesoriami w pudełku metalowym

	920A	○	10-11-12-13-14-17-19 22-24-27-30-32 mm
	920/21		125 mm
	920/22		255 mm
	920/25		
	920/42		
	920/55	⊕	







1/2"



920A/C12X  009200933

≡ 420x185x60 mm

Zestaw 22 nasadek sześciokątnych z akcesoriami w pudełku metalowym







1/4"		900	○	5-5,5-6-7-8-9-10-11-12-13 mm
		900/20		50 mm
		900/25		
1/2"		920A	○	10-13-14-15-17-18-19-22-24 27-30-32 mm
		920/21		125 mm
		920/25		
		920/55	⊕	



902A/C22  009020807

≡ 420x185x60 mm

Zestaw 12 nasadek sześciokątnych z akcesoriami w pudełku metalowym

	928A	○	22-24-27-30-32-34-36-38-41 46-50-55 mm
	928/21		200 mm
	928/22		380 mm
	928/25		
	928/42		
	928/55	⊕	

3/4"



928A/C12  009280955

≡ 530x220x80 mm



1/2"



≡ 195x80x55 mm

Komplet 10 nasadek uderowych w pudełku metalowym

10-11-12-13-14-17-19-22-24-27-30-32 mm

720/C12  007200912

Beta
GRIP



Zestaw 8 wkrętaków



1260 ● 2,5x50-3x75-4x100-5,5x125-6,5x150 mm



1262 ⊕ PH0x60-PH1x80-PH2x100 mm



1263/D8 012630008



Zestaw 10 wkrętaków



1260 ● 3x75-3,5x100-4x125-5,5x150-6,5x150 mm



1262 ⊕ PH0x60- PH1x80-PH2x100 mm



1260N ● 4x30 mm



1262N ⊕ PH1x30 mm



1263/D10 012630010



Zestaw 7 wkrętaków



1267TX ⊕ T6-T8-T10-T15-T20-T25-T30



1267TX/D7 012670307

Beta **EAASY**



Zestaw 8 wkrętaków



1201 ● 2,5x50-3x75-4x100-5,5x100-6,5x150 mm



1202 ⊕ PH0x60-PH1x80-PH2x100 mm



1203/D8P 012030018



Zestaw 10 wkrętaków



1201 ● 2,5x50-3x75-4x100-5,5x150-6,5x150 mm



1202 ⊕ PH0x60-PH1x80-PH2x100 mm



1201N ● 4x30 mm



1202N ⊕ PH1x30 mm



1203/D10N 012030019



Zestaw 12 wkrętaków



1201 ● 2,5x50-3x75-4x100-5,5x100-6,5x150-8x150 mm



1202 ⊕ PH0x60-PH1x80-PH2x100-PH3x150 mm

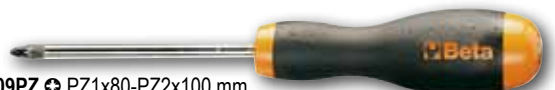

1209PZ ⊕ PZ1x80-PZ2x100 mm



1203/D12 012030012

Klucze dynamometryczne i wzmacniacze momentu



Nm	Kgfm	lbf.ft	□	■
1500	150	1106	1/2"	3/4"



Wzmacniacz momentu do użytku w obu kierunkach w walizce z tworzywa sztucznego

Przełożenie: 6,5:1

560/C6 005600160

400x260x110 mm

Wzmacniacz momentu do użytku w obu kierunkach w walizce z tworzywa sztucznego

Przełożenie: 12:1



Nm	Kgfm	lbf.ft	□	■
2500	250	1844	1/2"	1"

560/C12 005600210

400x260x110 mm

Wzmacniacz momentu o przełożeniu 25:1

Nm	Kgfm	lbf.ft	□	■	D mm	A mm	L mm
6000	600	4500	1/2"	1 1/2"	119	235	200

564/4R 005640004

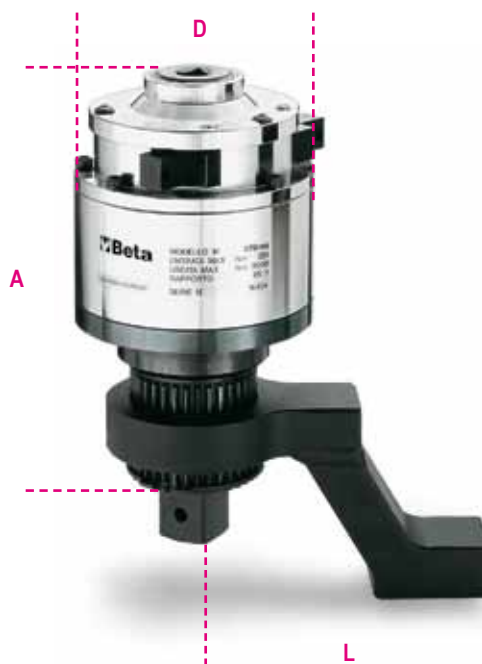

Klucze dynamometryczne klikowe z dwukierunkowym mechanizmem zapadkowym, dokładność: $\pm 4\%$



3/8" 8÷60 Nm L= 305 mm
606/6 006060105

1/2" 20÷100 Nm L= 345 mm
606/10X 006060111

1/2" 40÷200 Nm L= 440 mm
606/20 006060120

1/2" 60÷330 Nm L= 560 mm
606/30 006060130



NOWOŚĆ

MOMENT DOKRĘCANIA + KĄT OBROTU

Elektroniczny klucz dynamometryczny, odczyt momentu dokręcania i kąta dokręcania, dokładność przykręcania: $\pm 2\%$ zgodnie z ruchem wskazówek zegara, $\pm 3\%$ w kierunku przeciwnym do ruchu wskazówek zegara, w pudełku z tworzywa sztucznego

CE

1/2"

UNI EN 26789 ISO 6789



Pomiar kąta do 360°!



Dwukierunkowy mechanizm zapadkowy: do pracy w prawo lub w lewo
Dwa tryby pracy: wskazywanie wartości aktualnej lub osiągniętej wartości maksymalnej.

Dwustopniowa sygnalizacja: zielone diody LED, a później czerwone diody LED w połączeniu z brzęczykiem informują użytkownika, że ustawiona wartość momentu lub kąta została osiągnięta.

Oprogramowanie do przechowywania danych: umożliwia zapamiętanie do 9 wartości momentu/kąta

Antypoślizgowa rękojeść z kompozytu dwumateriałowego

Zasilanie: 2 baterie AA - 1,5V (w zestawie)

Nm	∠	Kgfm	lbf.ft	■	L mm
40÷200	0÷360°	4÷20	30÷150	1/2"	520



Oprogramowanie i kabel USB do przesłania danych na PC!

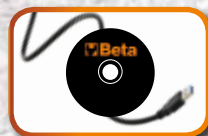

599DGT/A20 005990520